

Features

- High Efficiency (Up to 91%)
- Full Power at 50-100% Max Current (Constant Power)
- 0-10V/PWM/Timer Dimmable and Dim-to-Off
- Standby Power ≤ 1 W
- Input Surge Protection: 4kV line-line, 6kV line-earth
- All-Around Protection: OVP, SCP, OTP
- Waterproof (IP67) and UL Dry / Damp / Wet Location
- Class 2 & SELV Output
- TYPE HL, for use in a Class I, Division 2 hazardous (Classified) location

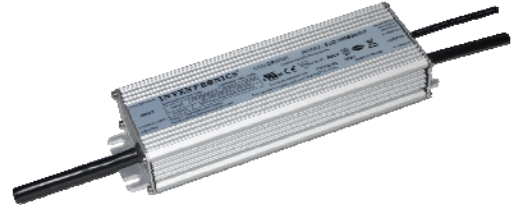

Description

The EUD-096SxxxDT series is a 96W, constant-current, programmable LED driver that operates from 90-305 Vac input with excellent power factor. Created for low bay, tunnel and street lights, it provides a dim-to-off mode with low standby power. The high efficiency of these drivers and compact metal case enables them to run cooler, significantly improving reliability and extending product life. To ensure trouble-free operation, protection is provided against input surge, output over voltage, short circuit, and over temperature.

Models

Adjustable Output Current Range	Full-Power Current Range (1)	Default Output Current	Input Voltage Range(2)	Output Voltage Range	Max. Output Power	Typical Efficiency (3)	Power Factor		Model Number
							120Vac	220Vac	
45-900mA	450-900mA	700 mA	90~305 Vac/ 127~300 Vdc	64~214Vdc	96 W	91.0%	0.99	0.96	EUD-096S090DT
90-1800mA	900-1800mA	1050 mA	90~305 Vac/ 127~300 Vdc	32~107Vdc	96 W	90.5%	0.99	0.96	EUD-096S180DT ⁽⁴⁾
180-3600mA	1800-3600mA	2100 mA	90~305 Vac/ 127~300 Vdc	16~53 Vdc	96 W	90.0%	0.99	0.96	EUD-096S360DT ⁽⁵⁾

Notes: (1) Output current range with constant power at 96W

(2) UL, FCC certified input voltage range: 100-277Vac or 127-300Vdc; other certified input voltage range except UL & FCC: 100-240Vac or 127-250Vdc

(3) Measured at a 220 Vac input with 50% maximum output current and 100% maximum output voltage.

(4) SELV Output

(5) Class2 & SELV Output

I-V Operating Area

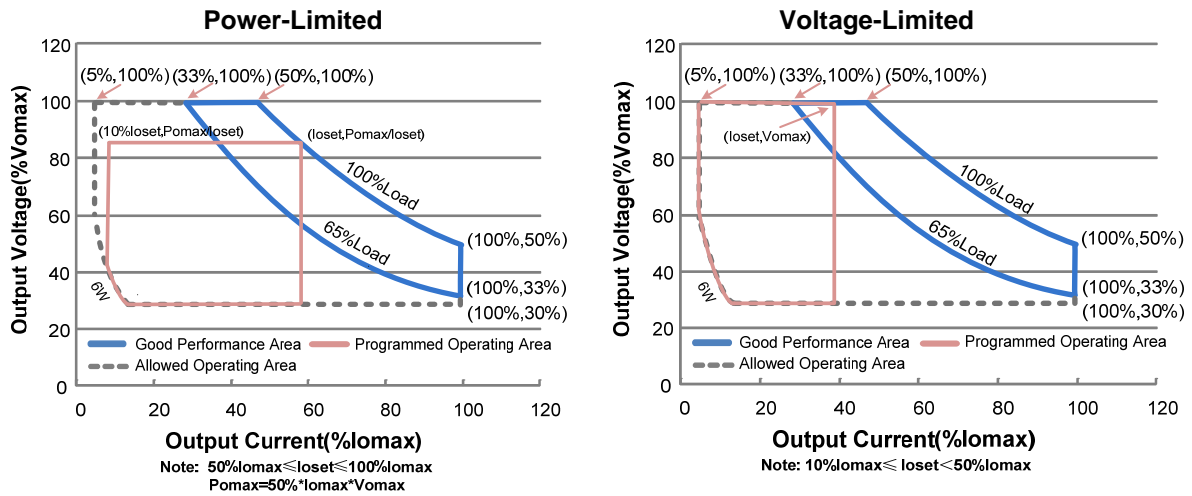

Input Specifications

Parameter	Min.	Typ.	Max.	Notes
Input Voltage	90 Vac	-	305 Vac	127~300 Vdc
Input Frequency	47 Hz	-	63 Hz	
Leakage Current	-	-	0.75 MIU	UL8750; 277Vac/ 60Hz
	-	-	0.70 mA	IEC60598-1; 240Vac/ 60Hz
Input AC Current	-	-	1.3 A	Measured at full load and 100 Vac input.
	-	-	0.6 A	Measured at full load and 220 Vac input.
Inrush Current(I ² t)	-	-	2.4 A ² s	At 220Vac input, 25°C Cold Start, Duration=1.0 ms, 10%I _{pk} -10%I _{pk} . See Inrush Current Waveform for the details.
PF	0.90	-	-	At 100-277Vac, 50-60Hz, 65%-100% Load (63-96W)
THD	-	-	20%	

Output Specifications

Parameter	Min.	Typ.	Max.	Notes
Output Current Tolerance	-5%I _{oset}	-	5%I _{oset}	At full load condition
Output Current Setting(I _{oset}) Range	10%I _{omax}	-	100%I _{omax}	
Output Current Setting Range with Constant Power	50%I _{omax}	-	100%I _{omax}	
Total Output Current Ripple (pk-pk)	-	5%I _{omax}	10%I _{omax}	At full load condition, 20 MHz BW
Output Current Ripple at < 200 Hz (pk-pk)	-	1%I _{omax}	-	At full load condition. Only this component of ripple is associated with visible flicker.

Output Specifications (Continued)

Parameter	Min.	Typ.	Max.	Notes
Startup Overshoot Current	-	-	10%Iomax	At full load condition
No-load Output Voltage				
EUD-096S090DT	-	-	240 V	
EUD-096S180DT	-	-	119 V	
EUD-096S360DT	-	-	59.5 V	
Line Regulation	-	-	±0.5%	Measured at full load
Load Regulation	-	-	±1.5%	
Turn-on Delay Time	-	0.8 s	1.5 s	Measured at 120Vac and 220Vac input, 65%-100% Load
Temperature Coefficient of I _o set	-	0.03%/°C	-	Case temperature = 0°C ~T _c max
12V Auxiliary Output Voltage	10.8 V	12 V	13.2 V	
12V Auxiliary Output Source Current	0 mA	-	200 mA	Return terminal is "Dim"

Note: All specifications are typical at 25°C unless otherwise stated.

General Specifications

Parameter	Min.	Typ.	Max.	Notes
Efficiency at 120 Vac input:				
EUD-096S090DT				
I _o = 450 mA	85.5%	88.5%	-	Measured at full load and steady-state temperature in 25°C ambient; (Efficiency will be about 2.0% lower if measured immediately after startup.)
I _o = 900 mA	84.5%	87.5%	-	
EUD-096S180DT				
I _o = 900 mA	85.0%	88.0%	-	
I _o =1800 mA	84.0%	87.0%	-	
EUD-096S360DT				
I _o =1800 mA	84.5%	87.5%	-	
I _o =3600 mA	83.0%	86.0%	-	
Efficiency at 220 Vac input:				
EUD-096S090DT				
I _o = 450 mA	89.0%	91.0%	-	Measured at full load and steady-state temperature in 25°C ambient; (Efficiency will be about 2.0% lower if measured immediately after startup.)
I _o = 900 mA	88.0%	90.0%	-	
EUD-096S180DT				
I _o = 900 mA	88.5%	90.5%	-	
I _o =1800 mA	87.5%	89.5%	-	
EUD-096S360DT				
I _o =1800 mA	88.0%	90.0%	-	
I _o =3600 mA	86.5%	88.5%	-	
Efficiency at 277 Vac input:				
EUD-096S090DT				
I _o = 450 mA	89.5%	91.5%	-	Measured at full load and steady-state temperature in 25°C ambient; (Efficiency will be about 2.0% lower if measured immediately after startup.)
I _o = 900 mA	88.5%	90.5%	-	
EUD-096S180DT				
I _o = 900 mA	89.0%	91.0%	-	
I _o =1800 mA	88.0%	90.0%	-	
EUD-096S360DT				
I _o =1800 mA	88.5%	90.5%	-	
I _o =3600 mA	87.0%	89.0%	-	

General Specifications (Continued)

Parameter	Min.	Typ.	Max.	Notes
Standby power	-	-	1 W	Measured at 230Vac/50Hz; Dimming off
MTBF	-	212,000 Hours	-	Measured at 220Vac input, 80%Load and 25°C ambient temperature (MIL-HDBK-217F)
Lifetime	-	111,000 Hours	-	Measured at 220Vac input, 80%Load and 60°C case temperature; See lifetime vs. Tc curve for the details
Operating Case Temperature for Safety Tc_s	-40°C	-	+86.6°C	
Operating Case Temperature for Warranty Tc_w	-40°C	-	+70°C	
Storage Temperature	-40°C	-	+85°C	Humidity: 5%RH to 100%RH
Dimensions Inches (L × W × H) Millimeters (L × W × H)	7.64 × 2.66 × 1.44 194 × 67.5 × 36.5			With mounting ear 8.70 × 2.66 × 1.44 221 × 67.5 × 36.5
Net Weight	-	985 g	-	

Note: All specifications are typical at 25°C unless otherwise stated.

Dimming Specifications

Parameter	Min.	Typ.	Max.	Notes
Absolute Maximum Voltage on the Vdim (+) Pin	-20 V	-	20 V	
Source Current on Vdim (+) Pin	200 uA	300 uA	450 uA	Vdim(+) = 0 V
Dimming Output Range	10%loset	-	loset	50%lomax ≤ loset ≤ 100%lomax
	5%lomax	-	loset	10%lomax ≤ loset < 50%lomax
Recommended Dimming Input Range	0 V	-	10 V	Default 0-10V dimming mode.
Dim off Voltage	0.35 V	0.5 V	0.65 V	
Dim on Voltage	0.55 V	0.7 V	0.85 V	
Hysteresis	-	0.2 V	-	

Dimming Specifications

Parameter	Min.	Typ.	Max.	Notes
PWM_in High Level	3 V	-	10 V	Dimming mode set to PWM in PC interface.
PWM_in Low Level	-0.3 V	-	0.6 V	
PWM_in Frequency Range	200 Hz	-	3 KHz	
PWM_in Duty Cycle	1%	-	99%	
PWM Dimming off (Positive Logic)	3%	5%	8%	
PWM Dimming on (Positive Logic)	5%	7%	10%	
PWM Dimming off (Negative Logic)	92%	95%	97%	
PWM Dimming on (Negative Logic)	90%	93%	95%	
Hysteresis	-	2%	-	

Note: All specifications are typical at 25°C unless otherwise stated.

Safety & EMC Compliance

Safety Category	Standard
UL/CUL	UL 8750,UL1310,CAN/CSA-C22.2 No. 250.13,CAN/CSA-C22.2 No. 223-M91
CE	EN 61347-1, EN61347-2-13
KS	KS C 7655
EMI Standards	Notes
EN 55015 ⁽¹⁾	Conducted emission Test & Radiated emission Test
EN 61000-3-2	Harmonic current emissions
EN 61000-3-3	Voltage Fluctuations & Flicker
FCC Part 15 ⁽¹⁾	ANSI C63.4 Class B
	This device complies with Part 15 of the FCC Rules. Operation is subject to the following two conditions: [1] this device may not cause harmful interference, and [2] this device must accept any interference received, including interference that may cause undesired Operation.
EMS Standards	Notes
EN 61000-4-2	Electrostatic Discharge(ESD): 8kV air discharge, 4kV contact discharge
EN 61000-4-3	Radio-Frequency Electromagnetic Field Susceptibility Test-RS
EN 61000-4-4	Electrical Fast Transient/Burst-EFT
EN 61000-4-5	Surge Immunity Test: AC Power Line: line to line 4kV, line to earth 6kV

Safety & EMC Compliance (Continued)

EMS Standards	Notes
EN 61000-4-6	Conducted Radio Frequency Disturbances test-CS
EN 61000-4-8	Power Frequency Magnetic Field Test
EN 61000-4-11	Voltage Dips
EN 61547	Electromagnetic Immunity Requirements Applies To Lighting Equipment

Note: (1) This LED driver meets the EMI specifications above, but EMI performance of a luminaire that contains it depends also on the other devices connected to the driver and on the fixture itself.

Lifetime vs. Case Temperature

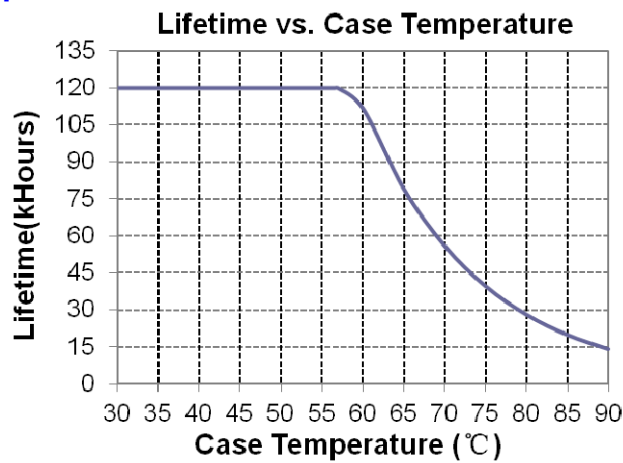

Inrush Current Waveform

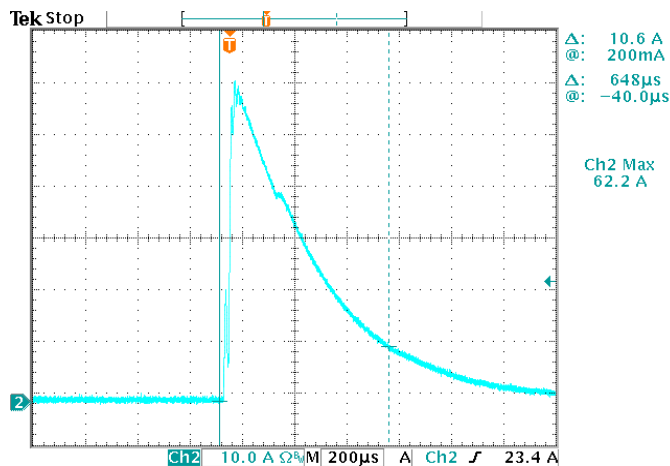

Efficiency vs. Load

EUD-096S090DT ($I_o=450mA$)

Efficiency vs. Output Voltage

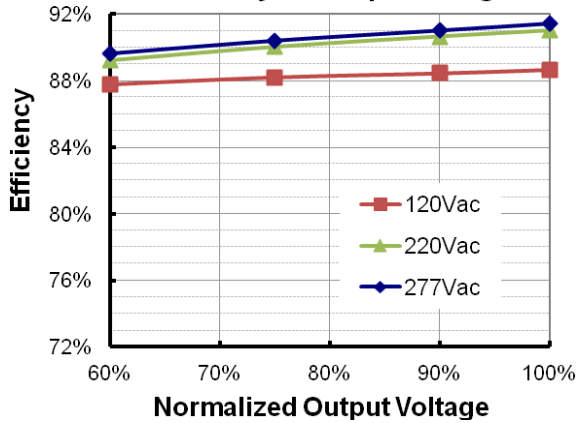

EUD-096S090DT ($I_o=900mA$)

Efficiency vs. Output Voltage

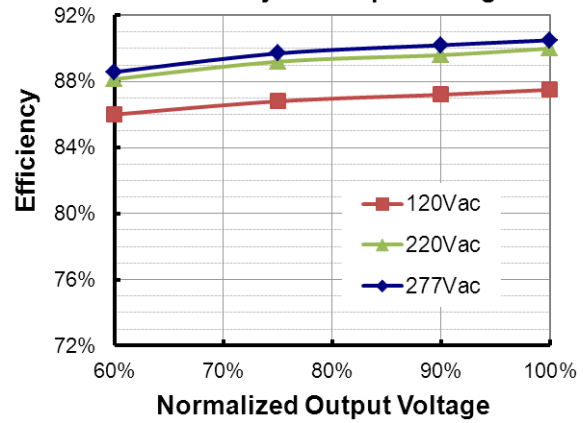

EUD-096S180DT ($I_o=900mA$)

Efficiency vs. Output Voltage

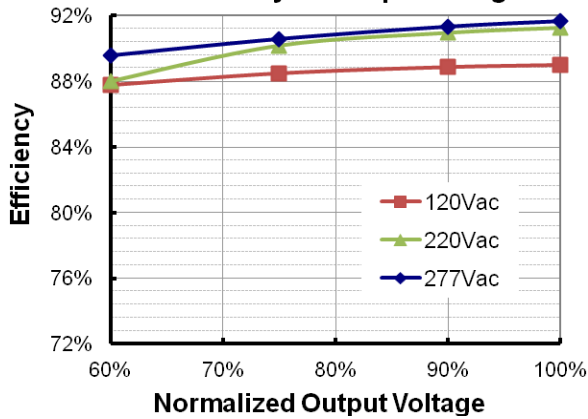

EUD-096S180DT ($I_o=1800mA$)

Efficiency vs. Output Voltage

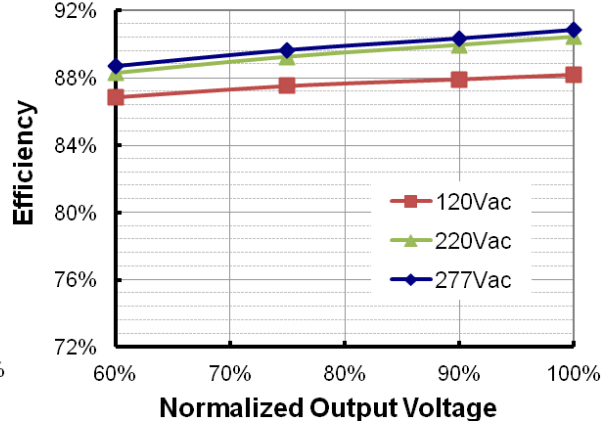

EUD-096S360DT ($I_o=1800mA$)

Efficiency vs. Output Voltage

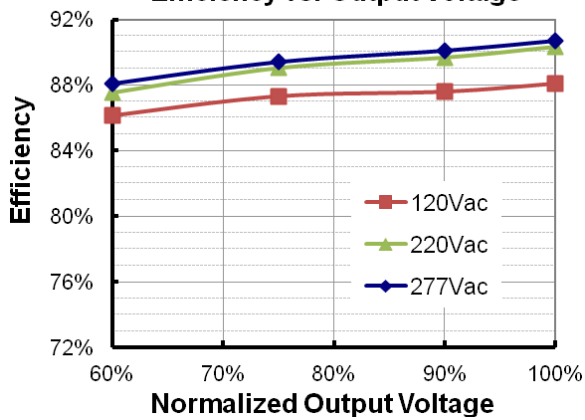

EUD-096S360DT ($I_o=3600mA$)

Efficiency vs. Output Voltage

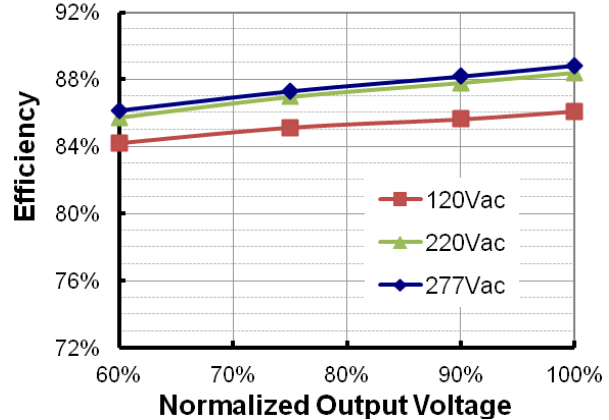

Power Factor

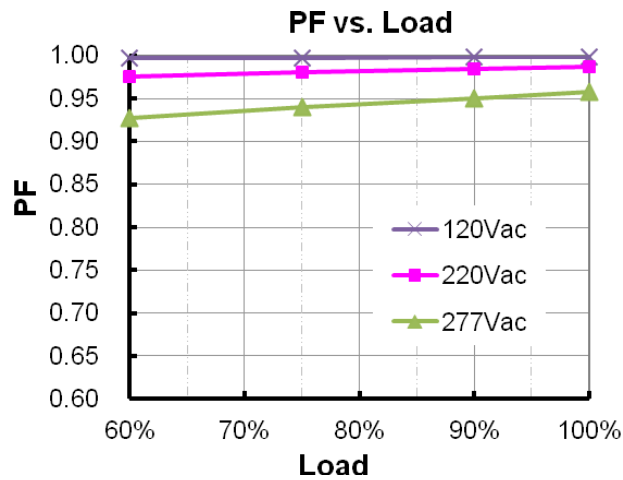

Total Harmonic Distortion

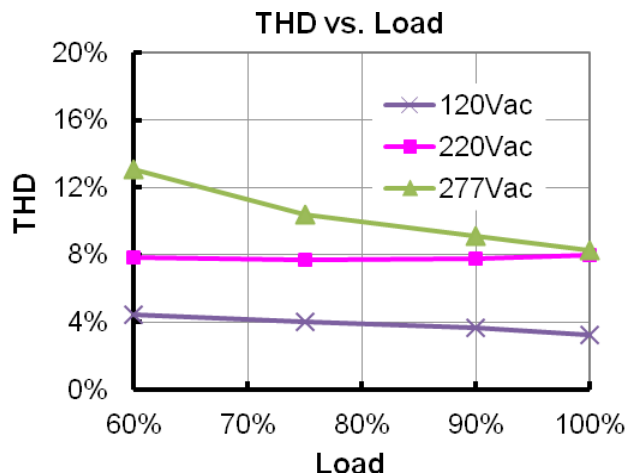

Protection Functions

Parameter	Notes
Over Temperature Protection	Decreases output current, returning to normal after over temperature is removed.
Short Circuit Protection	Auto Recovery. No damage will occur when any output is short circuited. The output shall return to normal when the fault condition is removed.
Over Voltage Protection	Limits output voltage at no load and in case the normal voltage limit fails.

Dimming

● 0-10V Dimming

The recommended implementation of the dimming control is provided below.

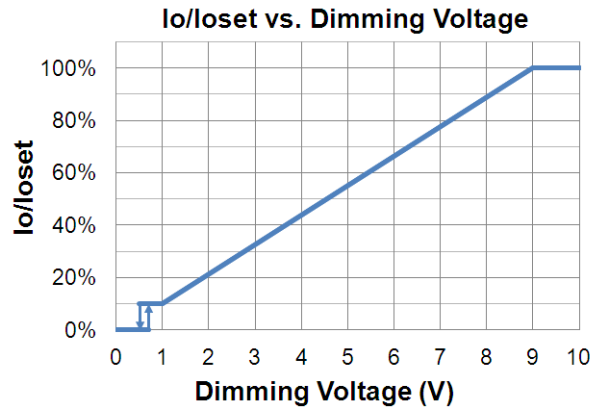
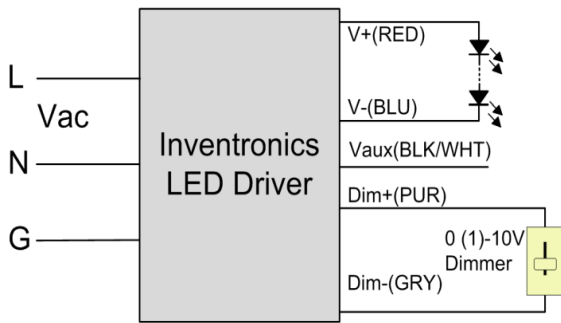

Implementation 1: DC Input

Notes:

1. The dimmer can also be replaced by an active 0-10V voltage source signal or passive components like resistors and zener.
2. Do NOT connect Dim- to the output V- or V+, otherwise the driver will not work properly.
3. If 0-10V dimming is not used, Dim + should be open.

● PWM Dimming

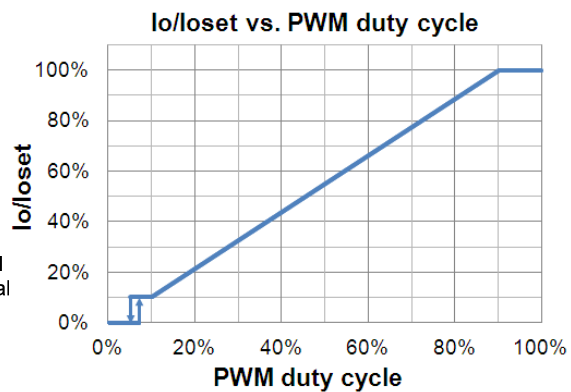
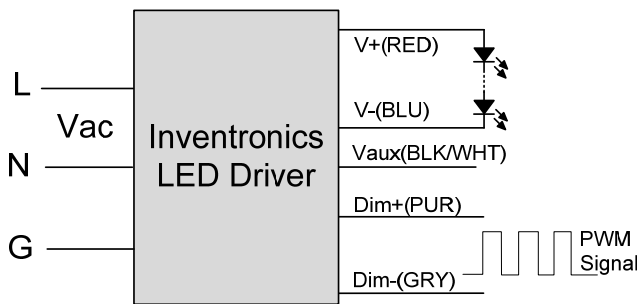

Implementation 2: Positive logic

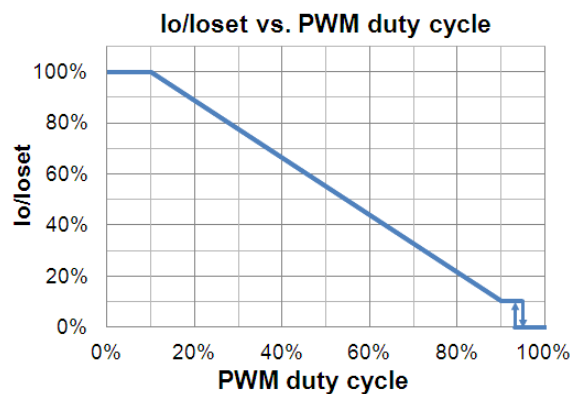
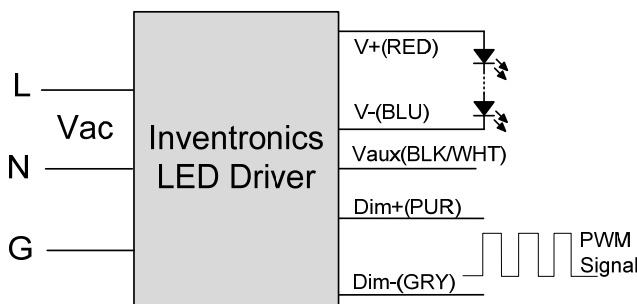

Implementation 3: Negative logic

● Time Dimming

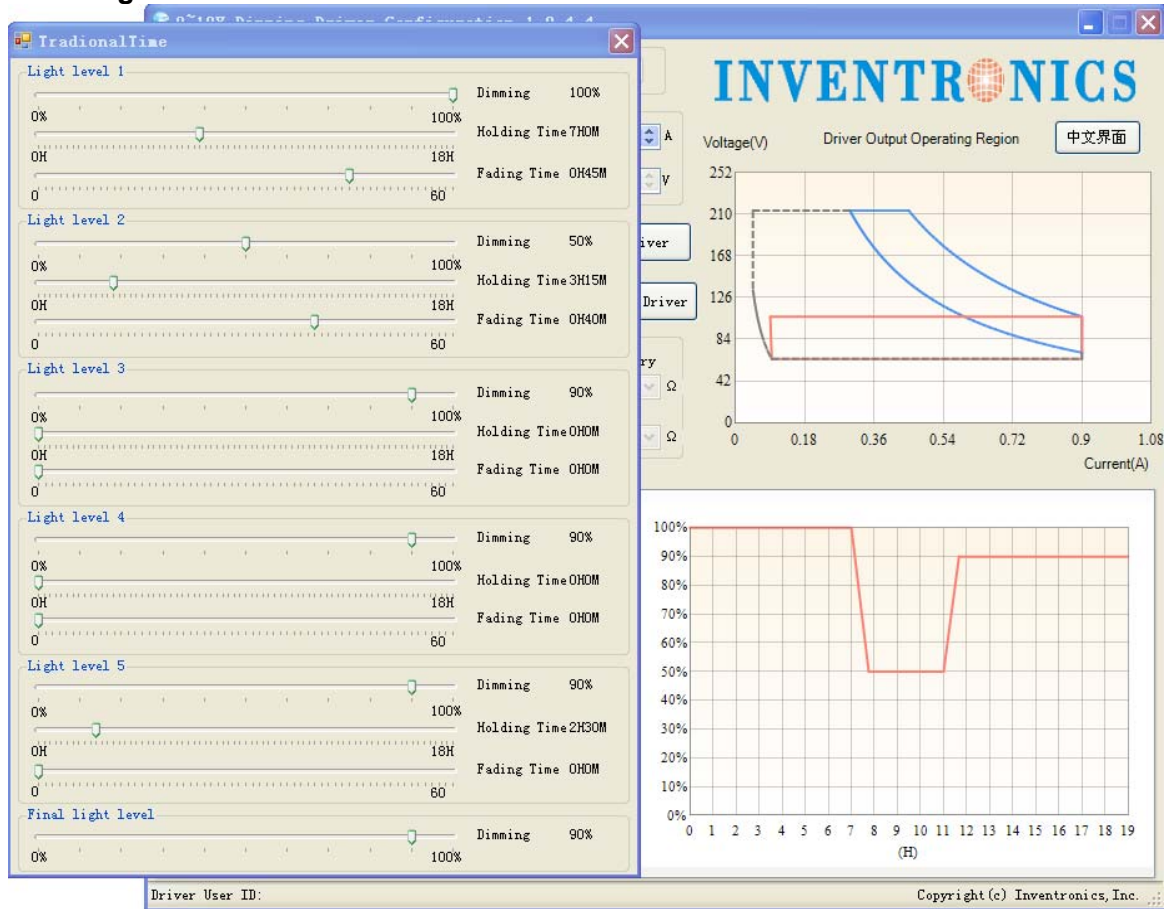

Set the timing curve by pulling the sliders.

Programming Connection Diagram

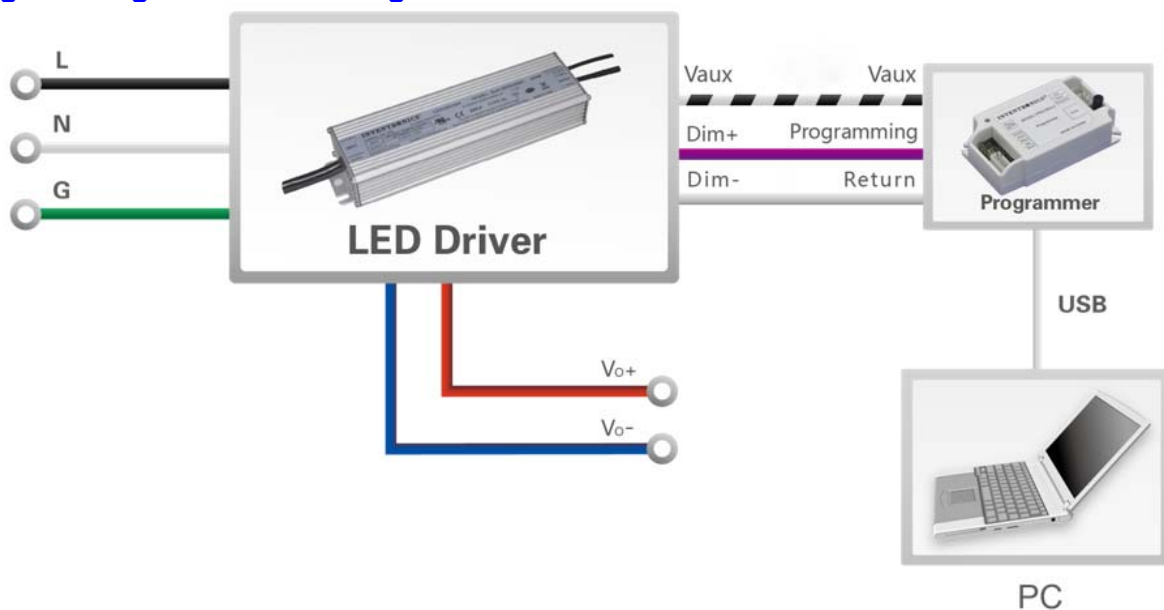

Note: The driver does not need to be powered on during the programming process.

- Please refer to [PRG-MUL2](#) Multi-Programmer datasheet for details.

Mechanical Outline

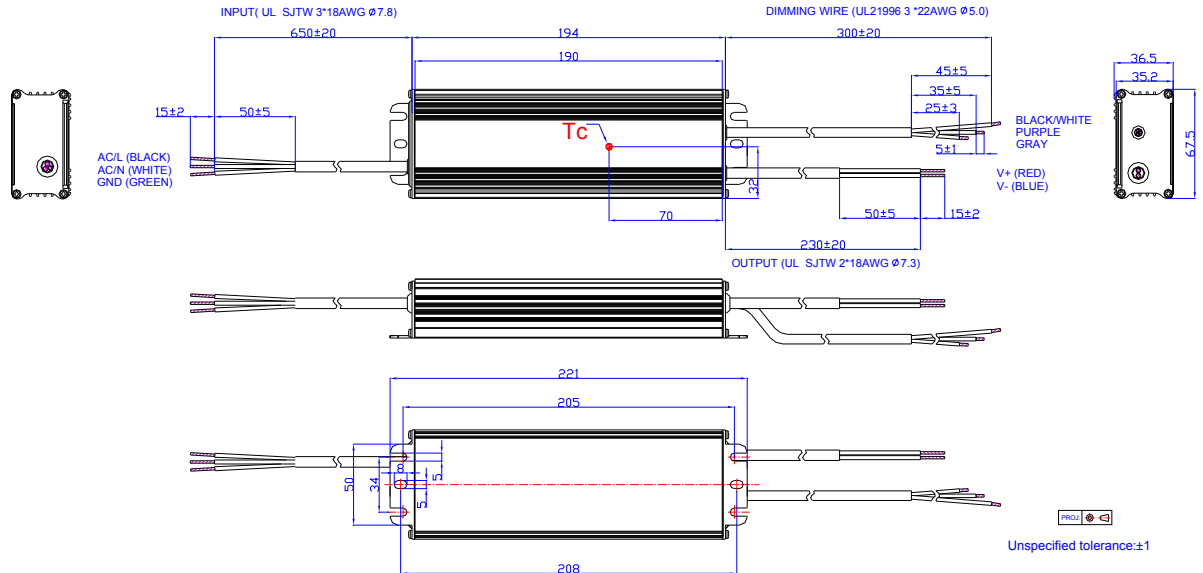

RoHS Compliance

Our products comply with the European Directive 2011/65/EC, calling for the elimination of lead and other hazardous substances from electronic products.

Revision History

Change Date	Rev.	Description of Change		
		Item	From	To
2014-08-30	A	Datasheets Release	/	/
2015-3-30	B	Features	/	Input Surge Protection: 4kV line-line, 6kV line-earth
		Output Specifications	Output Current Ripple(pk-pk)	Total Output Current Ripple (pk-pk)
		Output Current Ripple at < 200 Hz (pk-pk)	/	Added
		General Specifications	Case Temperature	Operating Case Temperature for Safety T _{c_s}
		General Specifications	/	Operating Case Temperature for Warranty T _{c_w}
		General Specifications	/	Storage Temperature
		Environmental Specifications	/	Delete
		Derating	/	Delete
		Time Dimming	/	Updated
2016-04-13	C	General Specifications	With mounting ear	Added
		General Specifications	Net Weight	Updated
		Dimming Specifications	/	Updated
		Safety & EMC Compliance	/	Updated
		Programming Connection Diagram	/	Updated
2016-07-11	D	Models	Adjustable Output Current Range	Updated
		I-V Operating Area	/	Updated
		Output Specifications	Output Current Setting(loset) Range	Updated
		Dimming Specifications	Dimming Output Range	Updated
		Mechanical Outline	/	Updated
2017-08-04	E	Models	/	Updated
		Input Specifications	PF/THD	Updated
		Output Specifications	Turn-on Delay Time	Updated
		Output Specifications	Temperature Coefficient of loset	Updated
		Safety & EMC Compliance	/	Updated

INVENTRONICS

EUD-096SxxxDT

Rev. E

96W Programmable IP67 Driver

		Mechanical Outline	/	Updated
--	--	--------------------	---	---------