

12/12/2012

**400 Watt M59 60Hz
Metal Halide**

Project:	
Catalog#:	
Approved by:	

Input Volts (60 hz)	120	208	240	277
Input Watts	458	458	458	458
Approx. Line Current (Amps)*	4.0	2.3	2.0	1.8
Circuit Type	CWA			
ANSI	M59			
Insulation Class	Class H			
Power Factor	> 90%			
Regulation	Line Volts: ±10% Lamp Watts: ±10%			
Min. Ambient Starting Temp.	-20°F/-30°C			
High Potential Test (Volts)	1 Minute: 1700 1 Second: 2000			
Lead Lengths (inches)	12			
UL Temperature Ratings*	1029E			
Capacitor	24.0/400v Min. Included in kit.			

* See Ballast Label for exact values and additional information

WIRING DIAGRAM

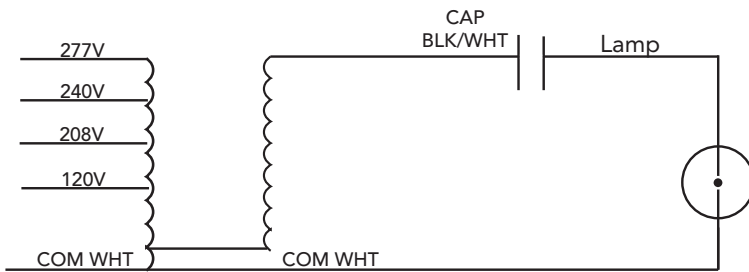

HID Ballast Kit

- Ballast
- Capacitor
- Mounting Bracket

DIMENSIONAL DRAWING

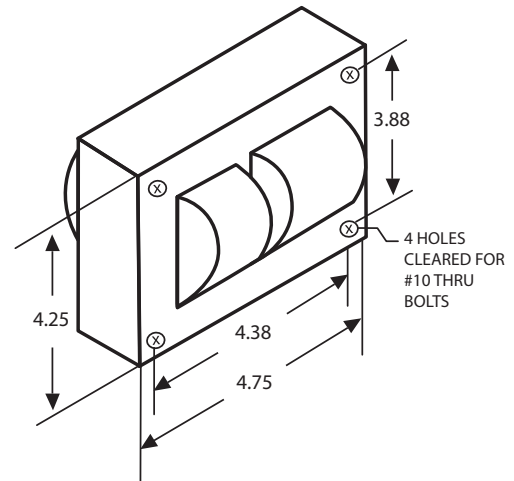

Specifications subject to change without notice.



High Intensity Discharge Ballasts