

QUICKTRONIC® PROStart® T5HO 347-480V High Ambient Temp. Systems



Type CC
Programmed Rapid Start
Normal Ballast Factor HT

High Efficiency Series

Lamp / Ballast Guide

54W T5 - PENTRON® HO lamps
1 or 2-lamp:
QHE2x54T5HO/347-480 PSN-HT
(no-leads)
QHE2x54T5HO/347-480 PSN-HT-MCL
(leads)
4-lamp Switchable:
QHE4x54T5HO/347-480 PSN-HT-SCL
Also operates:
FP54/SS, FT50DL, FT55DL, FPC55, L58T8
1 or 2 lamps on 2L ballast
1,2,3 or 4 lamps on 4L ballast

Key System Features

- High Efficiency Systems over 90% efficient
- 90°C maximum case temp.
- 347-480V input voltage range
- 100% ballast factor (see table)
- QUICKSENSE® ballast technology (end-of-lamp-life sensing)
- PROStart programmed rapid start
- UL type CC rated
- -20°F/-29°C min. starting temp.
- Operates at >42 kHz to reduce potential interference with infrared control systems
- High power factor
- Low harmonic distortion
- Lightweight
- UL, CSA, FCC
- RoHS compliant
- Lead-free solder, printed circuit board and manufacturing process



Recommended for use with Occupancy Sensors

SYLVANIA QUICKTRONIC High Efficiency (QHE) PROStart® T5HO 347-480V High Ambient (HT) electronic ballasts operate PENTRON HO, PENTRON HO Circline, and DULUX® L T5 lamps with full lumen output and optimal system performance.

QUICKTRONIC 347-480V T5HO HT electronic ballasts allow operation in industrial applications using a 480V AC system. This eliminates the need to rewire existing 480V installations or to drop the voltage by using expensive and bulky transformers. The same product can also be used for 347V applications, allowing for a reduction in inventory model numbers.

QUICKTRONIC 347-480V T5HO HT ballasts are specifically designed for high ambient temperature applications. The ballast may be operated at case temperatures of up to 90°C, making them an ideal choice for high ambient settings such as industrial high-bay lighting.

System Information

SYLVANIA QUICKTRONIC High Efficiency PROStart T5HO 347-480V High Ambient System:

- Voltage errors
 - Reduces inventory by 50%
- Utilizes Programmed Rapid Start operation for:
 - Highest System Efficacy
 - Longer Life
 - Over 100,000 switching cycles for occupancy sensor and building control systems applications

QUICKSENSE ballast technology helps to protect against overheated bases and sockets, as well as cracking of the glass wall, and uses dynamic end-of-lamp-life sensing to avoid false shutdowns caused by some static sensing methods. QUICKSENSE ballast technology will auto reset when the end-of-life lamps are replaced with new ones.

The two lamp unit can be wired for two or one lamp operation. The four lamp "switching" ballast is designed to switch from 4 to 2-lamps, 3 to 2-lamps, 3 to 1-lamp or 2 to 1-lamp. The switching feature can be used with control interfaces, including occupancy sensors.

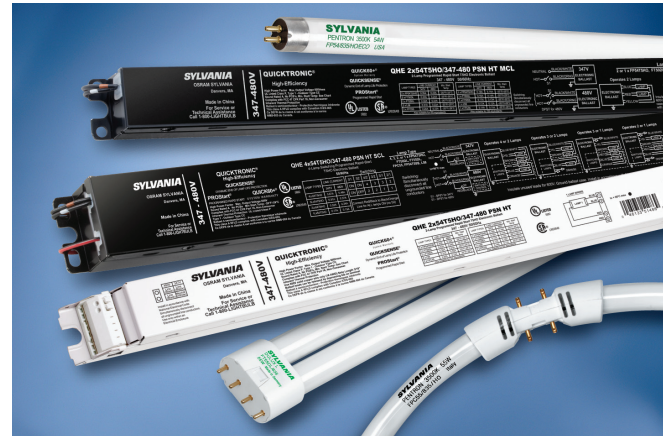

QUICKTRONIC 347-480V T5HO HT ballasts are RoHS compliant and feature lead-free solder, printed circuit boards and manufacturing process.

Setting the standard for quality, QUICKTRONIC 347-480V T5HO HT ballasts are covered by the QUICK 60+® warranty, the first and most comprehensive system warranty in the industry.

System Type	Input System Power (W)	Initial Fixture* LPW	Mean Fixture* Lumens	Relative Fixture* Output	Energy Savings (%)
M400/U (1-lamp) Magnetic Ballast	452	61	17,784	Baseline	Baseline
FP54T5HO (4-lamps) QHE4x54T5HO/347-480 PSN-HT-SCL	228	79	16,740	94%	50%
FP54/50W/SS (4-lamps) QHE4x54T5HO/347-480 PSN-HT-SCL	207	89	17,075	96%	54%
FP54/47W/SS (4-lamps) QHE4x54T5HO/347-480 PSN-HT-SCL	203	83	15,625	88%	55%

*Based on Fixture efficiency: 76% for M400 and 90% for FP54T5HO

*480V input voltage

*Lumen Output for T5HO @ 35°C/95°F

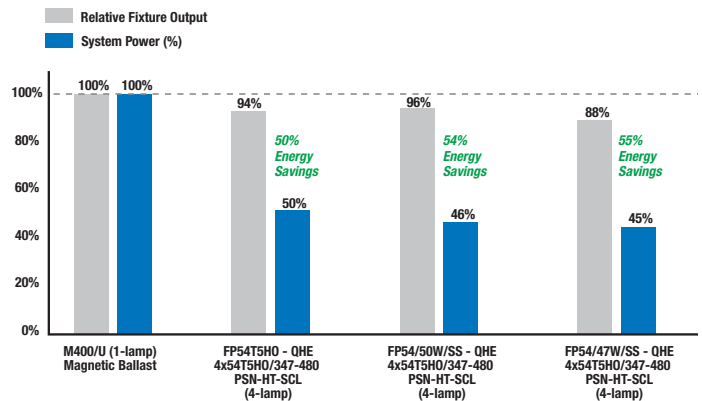

QHE T5HO
347-480V HT

SPECIFICATION DATA

Catalog #	Date	Type
Project	Prepared by	
Comments		

High Ambient Temp.

**T5HO 2 Lamp 347-480V HT
Fixed Output Ballast**

High Efficiency

Lamp / Ballast Guide

2 Lamp, High Efficiency, Type CC, High Ambient (347-480V)



Wiring Diagrams

**High Ambient Model (90°C case temp.)
51486 QHE2x54T5HO/347-480 PSN-HT
No Leads**

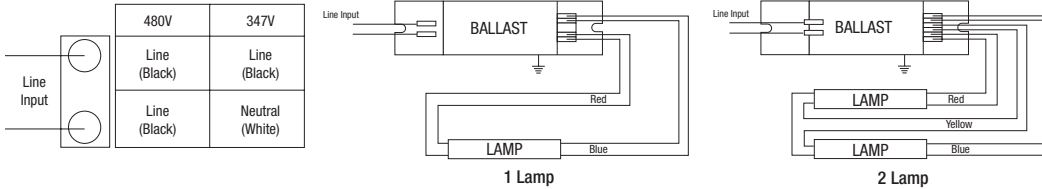

**High Ambient Model (90°C case temp.)
51485 QHE2x54T5HO/347-480 PSN-HT-MCL
With Leads**

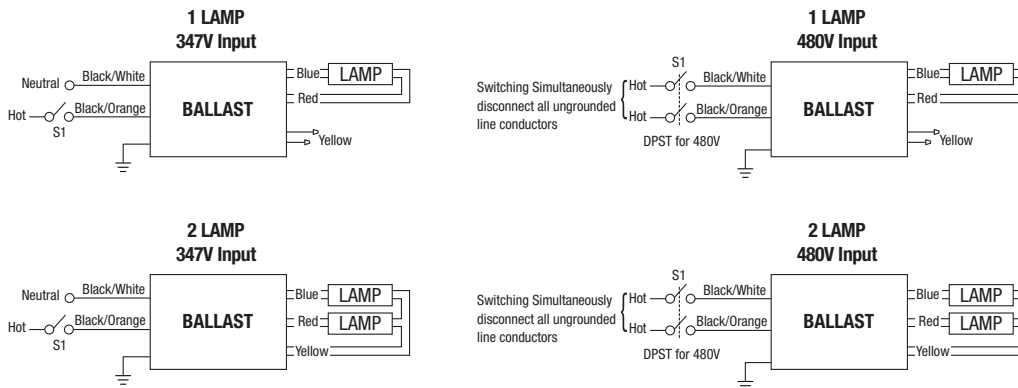

Installation Notes

- For 480V applications connect two phases (line and line) to the input.
- For 347V applications connect line and neutral to the input as shown (DO NOT CONNECT two phases of 347V to the same ballast)
- Switching: Simultaneously disconnect all ungrounded line conductors per NEC codes (i.e. switch both hot legs)
- Ground ballast case
- Insulate unused leads for 600V
- Install in accordance with the National Electrical Code

Dimensions:

Model QHE2x54T5HO/347-480 PSN-HT and QHE2x54T5HO/347-480 PSN-HT-MCL enclosure size:

Overall: 16.73"L x 1.18"W x 1.00"H (425mm L x 30mm W x 25.4mm H)

Mounting: 16.34" (415mm)

Wiring:

51486: Push-in connectors

Use 18AWG solid copper wire only

51485: Leads only (no connectors provided)

Product Weight:

51486: 0.88 lbs (0.40kg) each (approx)

51485: 1.0 lb (0.45kg) each (approx)

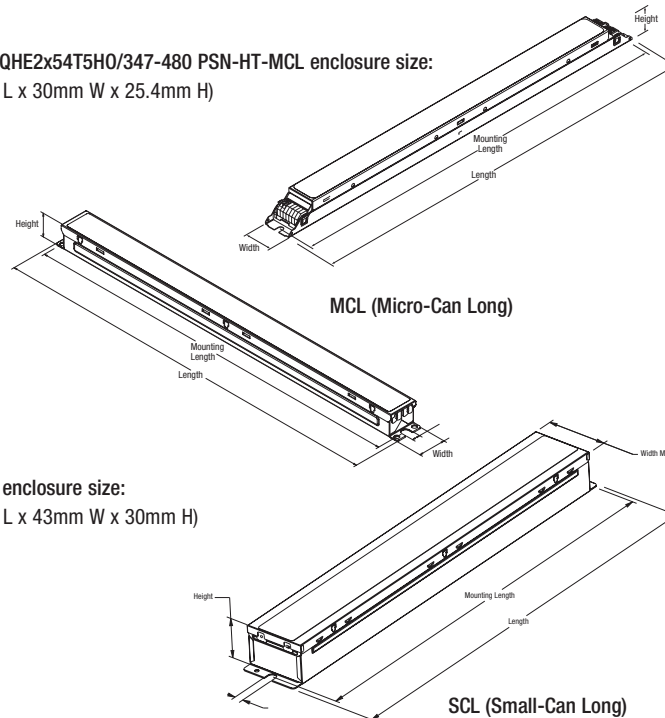

Dimensions:

Model QHE4x54T5HO/347-480 PSN-HT-SCL enclosure size:

Overall: 16.73"L x 1.68"W x 1.18"H (425mm L x 43mm W x 30mm H)

Mounting: 16.34" (415mm)

Wiring:

51481: Leads only (no connectors provided)

Product Weight:

51481: 2.4 lbs (1.08kg) each (approx)

**OSRAM SYLVANIA
National Customer
Service and Sales Center**
1-800-LIGHTBULB
(1-800-544-4828)
www.sylvania.com

Specifications subject to change without notice.



**QHE T5HO
347-480V HT**

SPECIFICATION DATA

Catalog #	Date	Type
Project	Prepared by	
Comments		

4 Lamp, High Efficiency, Type CC, High Ambient (347-480V)



Wiring Diagrams

High Ambient Switchable Model (90°C case temp.)
51481 QHE4x54T5H0/347-480 PSN-HT-SCL

4-Lamp Switching Wiring Diagram (4L to 2L)

S1	S2	4/2
ON	ON	4
ON	OFF	2

For fixed output, S2 not used.
Connect red/black lead to black/orange lead.

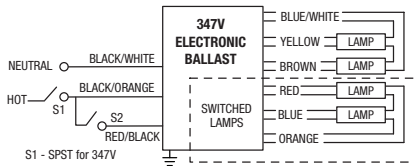

Operates 4 or 2 Lamps

Switching: Simultaneously disconnect all ungrounded line conductors

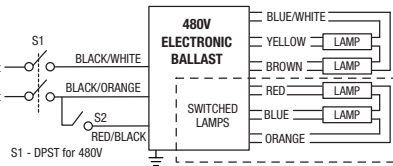

3-Lamp Switching Wiring Diagram (3L to 2L, 3L to 1L)

S1	S2	3/2	3/1
ON	ON	3	3
ON	OFF	2	1

Operates 3 or 2 Lamps

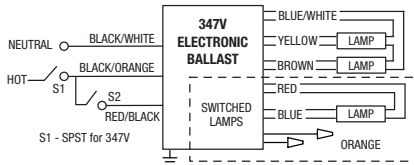

Switching: Simultaneously disconnect all ungrounded line conductors

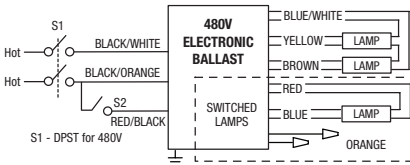

Operates 3 or 1 Lamps

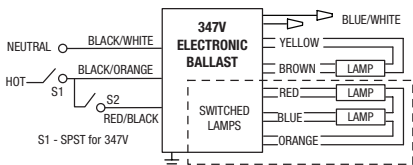

Switching: Simultaneously disconnect all ungrounded line conductors

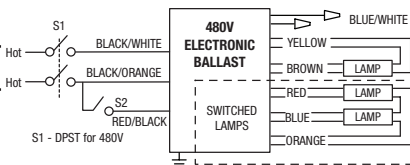

2-Lamp Switching Wiring Diagram (2L to 1L)

S1	S2	2/1
ON	ON	2
ON	OFF	1

Operates 2 or 1 Lamps

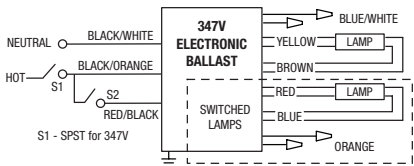

Switching: Simultaneously disconnect all ungrounded line conductors

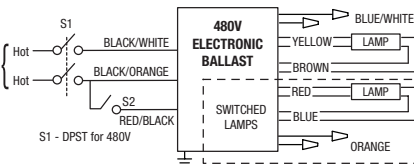

High Ambient Temp.

T5H0 4 Lamp 347-480V HT Switchable Ballast

High Efficiency

Lamp / Ballast Guide



**QHE T5H0
347-480V HT**

Installation Notes

- Install in accordance with National & Local Electric Code
- Ground ballast case
- Switching: Simultaneously disconnect all ungrounded line conductors
- For 480V applications connect two phases (line and line) to the input
- For 347V applications connect line and neutral to the input as shown (DO NOT CONNECT two phases of 347V to the same ballast)
- Insulate unused leads for 600V

Input wiring for occupancy sensor
Bi-level control
(S2 is the occupancy sensor)

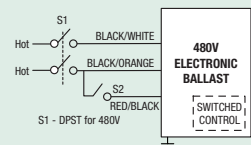
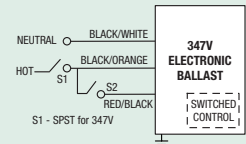

OSRAM SYLVANIA
National Customer
Service and Sales Center
1-800-LIGHTBULB
(1-800-544-4828)
www.sylvania.com

Specifications subject to change without notice.

SPECIFICATION DATA

Catalog #	Date	Type
Project	Prepared by	
Comments		

High Efficiency, Type CC, High Ambient (347-480V)



Item Number	OSRAM SYLVANIA Description	Input Current (AMPS)	Lamp Type	Rated Lumens (lm)	No. of Lamps	Ballast Factor (BF)	System Lumens	Mean Lumens	Input Power (Watts)		System Efficacy (lm/W)	BEF
									347V	480V		
QHE 2x54T5HO Fixed Output												
51486	QHE2x54T5HO/347-480 PSN-HT 20-pack (without leads)	0.35/0.25	FP54T5HO	5000	2	1.00	10,000	9300	118	117	85	0.85
		0.30/0.23	FP54/50W/SS	5000	2	1.00	10,000	9300	109	108	93	0.93
		0.30/0.22	FP54/47W/SS	4575	2	1.02	9335	8680	104	102	92	1.00
51485	QHE2x54T5HO/347-480 PSN-HT-MCL 10-pack (with leads)	0.32/0.23	FT55DL	4800	2	0.86	8255	7680	104	103	80	0.83
		0.33/0.24	FT50DL	4300	2	1.00	8600	8000	109	108	80	0.93
		0.31/0.22	L58	5200	2	1.00	10,400	9670	108	107	97	0.93
		0.26/0.22	FPC55	4000	2	0.75	6000	5040	91	90	67	0.83
		0.18/0.14	FP54T5HO	5000	1	1.00	5000	4650	60	59	85	1.69
		0.16/0.11	FP54/50W/SS	5000	1	1.01	5050	4695	56	55	92	1.84
		0.15/0.11	FP54/47W/SS	4575	1	0.98	4484	4170	52	51	88	1.92
		0.17/0.13	FT55DL	4800	1	0.87	4175	3885	55	54	77	1.61
		0.18/0.14	FT50DL	4300	1	1.02	4385	4080	57	56	78	1.82
		0.17/0.12	L58	5200	1	0.87	4525	4205	56	55	82	1.58
0.14/0.11	FPC55	4000	1	0.77	3080	2585	48	47	66	1.64		

QHE 4x54T5HO Switchable Model

51481	QHE4x54T5HO/347-480 PSN-HT-SCL 10-pack (with leads)	0.67/0.48	FP54T5HO	5000	4	1.00	20,000	18,600	232	228	88	0.44
		0.63/0.45	FP54/50W/SS	5000	4	1.02	20,400	18,970	212	207	99	0.49
		0.59/0.43	FP54/47W/SS	4575	4	1.02	18,665	17,360	205	203	92	0.50
		0.63/0.46	FT55DL	4800	4	0.91	17,470	16,250	217	215	81	0.42
		0.66/0.48	FT50DL	4300	4	1.02	17,545	16,315	225	222	79	0.46
		0.62/0.45	L58	5200	4	0.97	20,175	18,765	214	213	95	0.46
		0.51/0.37	FPC55	4000	4	0.88	14,080	13,095	181	175	80	0.50
		0.51/0.37	FP54T5HO	5000	3	1.03	15,450	14,370	178	177	87	0.58
		0.48/0.35	FP54/50W/SS	5000	3	1.02	15,300	14,230	165	164	93	0.62
		0.45/0.33	FP54/47W/SS	4575	3	1.04	14,275	13,275	156	155	92	0.67
		0.48/0.35	FT55DL	4800	3	0.92	13,250	12,320	165	163	81	0.56
		0.49/0.36	FT50DL	4300	3	1.03	13,285	12,355	170	167	80	0.62
		0.47/0.34	L58	5200	3	0.97	15,130	14,075	162	162	93	0.60
		0.41/0.30	FPC55	4000	3	0.92	11,040	10,265	144	141	78	0.65
		0.33/0.24	FP54T5HO	5000	2	1.03	10,300	9580	118	116	89	0.89
		0.32/0.24	FP54/50W/SS	5000	2	1.02	10,200	9485	108	106	96	0.96
		0.30/0.23	FP54/47W/SS	4575	2	1.03	9425	8765	103	101	93	1.02
		0.31/0.24	FT55DL	4800	2	0.93	8930	8305	107	106	84	0.88
		0.33/0.24	FT50DL	4300	2	1.04	8945	8320	112	109	82	0.95
		0.31/0.23	L58	5200	2	0.97	10,090	9380	106	106	95	0.92
0.27/0.20	FPC55	4000	2	0.90	7200	6695	91	89	81	1.01		
0.17/0.13	FP54T5HO	5000	1	1.05	5250	4885	59	58	91	1.81		
0.17/0.13	FP54/50W/SS	5000	1	1.03	5150	4790	56	55	94	1.87		
0.16/0.13	FP54/47W/SS	4575	1	1.04	4760	4425	53	53	90	1.96		
0.17/0.13	FT55DL	4800	1	0.90	4320	4020	56	55	79	1.64		
0.17/0.14	FT50DL	4300	1	1.04	4470	4160	57	57	78	1.82		
0.17/0.13	L58	5200	1	0.98	5095	4740	58	57	89	1.72		
0.14/0.12	FPC55	4000	1	0.95	3800	3535	55	53	72	1.79		

1: At 35°C lamp ambient temperature.
 2: Ballast Efficiency Factor (BEF) shown = (Ballast Factor x 100) divided by Input Power (Note: calculation based on lowest wattage value).
 3: System Efficacy calculation based on lowest input power value.
 * New Product. Please note item number 51486 connector/white case model QHE2x54T5HO/347-480 PSN-HT with leads inserted (for customer satisfaction) will be shipped as item number 51485 until the new black MCL (Micro-Can Long) case with leads QHE2x54T5HO/347-480 PSN-HT-MCL is in production. Check with your SYLVANIA Sales Professional for new product availability.

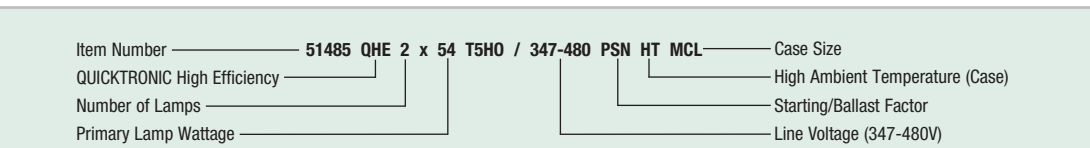

High Ambient Temp.

T5HO 347-480V HT

High Efficiency

Performance Guide

Data based upon SYLVANIA PENTRON® HO lamps shown. QUICKTRONIC® 347-480V T5HO HT ballasts are also compatible with other lamp manufacturers equivalent lamp types that meet ANSI specifications.

Specifications⁴

- Starting Method: Programmed Rapid Start
- Ballast Factor: 1.00 (see table)
- Circuit Type: Series
- Lamp Frequency: >42 kHz
- Lamp CCF: Less than 1.6
- Starting Temp: -20°F/-29°C⁵
- Input Frequency: 50/60 Hz
- Low THD: <10%
- Power Factor: >98%
- Voltage Range: ±10% of Rated Input

- UL Listed Class P, Type 1, Outdoor, UL Type CC Rated
- CSA Certified
- High Ambient Applications: 90°C Max. Case Temp. (3 yr. warranty)
- Standard Ambient Applications: 70°C Max. Case Temp. (5 yr. warranty)
- FCC 47CFR Part 18 Non-Consumer Class A Sound Rating
- RoHS Compliant⁶
- ANSI C62.41 Cat. A Transient Protection
- QUICKSENSE® Dynamic End-of-Lamp-Life Sensing
- Remote Mounting (Max. wire length from ballast case to lampholder): up to 18 feet. Remote red leads up to 18 feet. Keep blue leads <10 feet.⁵

4 Data based on PENTRON HO lamp types for primary ballast application.
 5 Operation below 50°F (10°C) may affect light output or lamp operation – see “Low Temp. Starting” definition.
 6 Complies with European Union Restriction of Hazardous Substances Directive. (Directive 2002/95/EC)

System Life / Warranty

QUICKTRONIC products are covered by the QUICK 60+® warranty, a comprehensive lamp and ballast system warranty. For additional details, refer to the QUICK 60+ warranty bulletin.

OSRAM SYLVANIA National Customer Service and Sales Center
 1-800-LIGHTBULB (1-800-544-4828)
 www.sylvania.com

Specifications subject to change without notice.

QHE T5HO 347-480V HT